

Longday Bar Cart

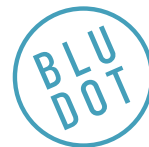

DESIGNED IN 2019

ASSEMBLY NOTES | REV 01

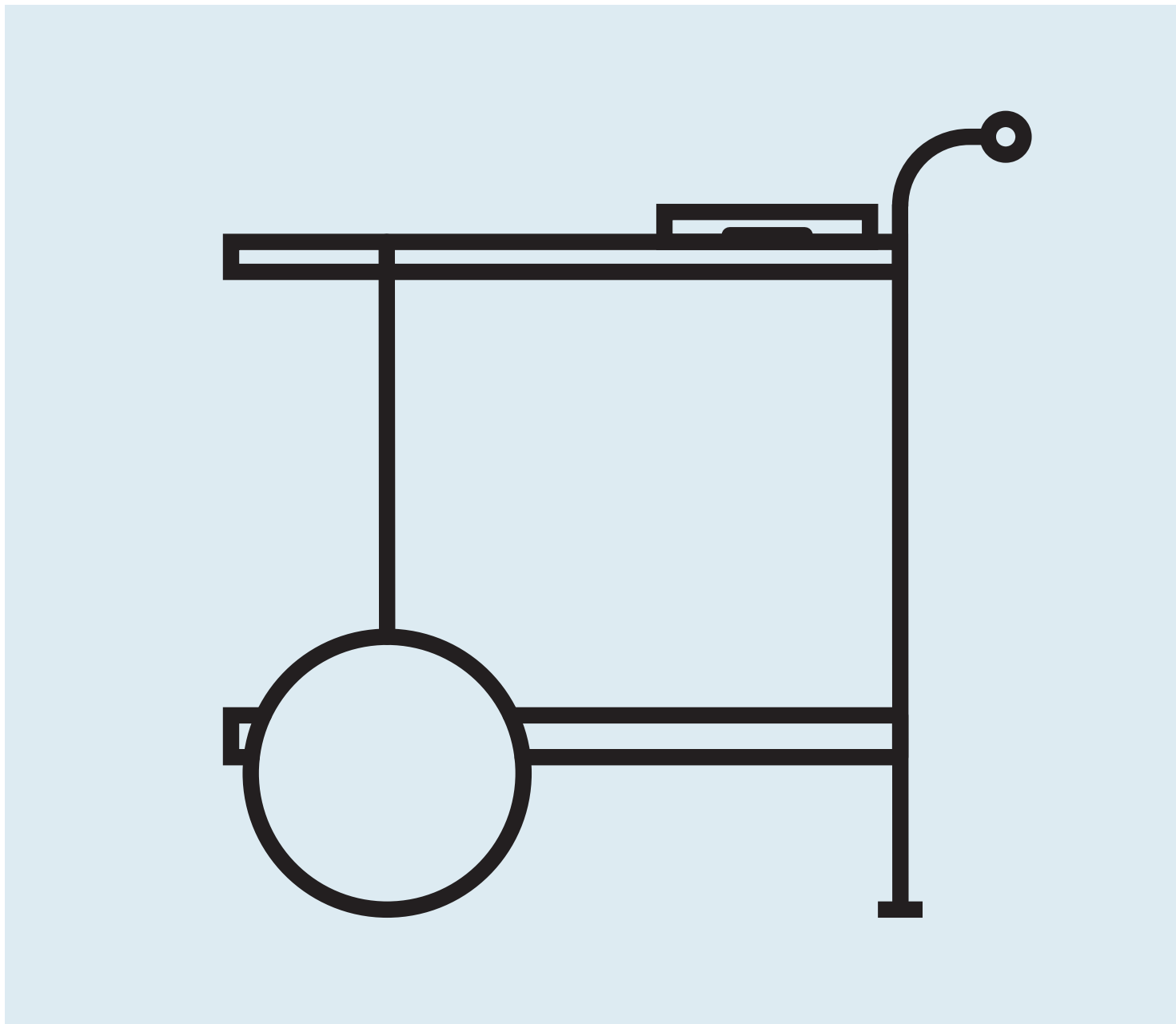

NEED A HAND?

Contact us at service@bludot.com or
844.425.8368 for assistance.

@BLUDOT

We design all our pieces in our Minneapolis studio. Follow
along on Instagram for some sneak peeks into the process.

Parts & Hardware

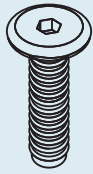

QTY _____ 6

PT. 1694

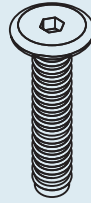

QTY _____ 2

PT. 1695

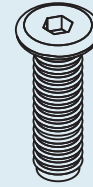

QTY _____ 2

PT. 1681

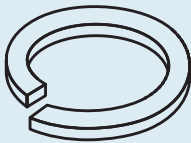

QTY _____ 8

PT. 3001

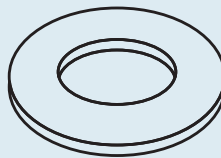

QTY _____ 8

PT. 3002

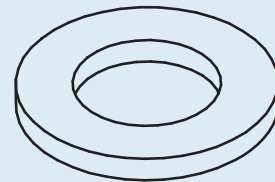

QTY _____ 2

Wheel Washer

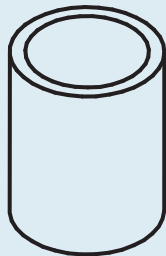

QTY _____ 4

Wheel Bushing

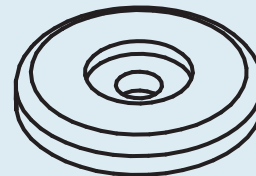

QTY _____ 2

Wheel End Cap

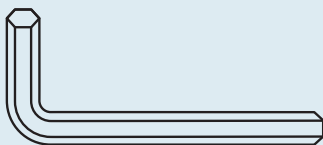

QTY _____ 1

PT. 9004

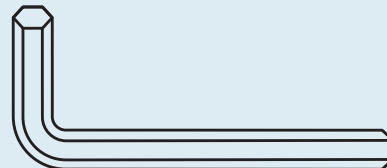

QTY _____ 1

PT. 9001

Parts & Hardware



QTY 1

Handle A

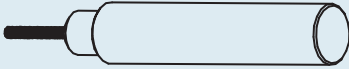

QTY 1

Handle B

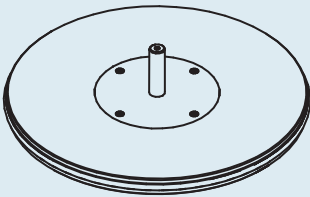

QTY 2

Wheel

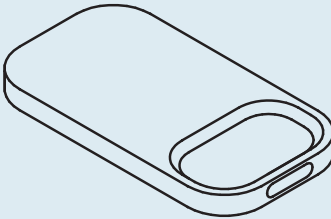

QTY 1

Tray

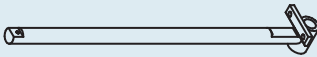

QTY 2

Short Upright

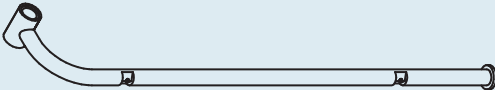

QTY 1

Tall Upright

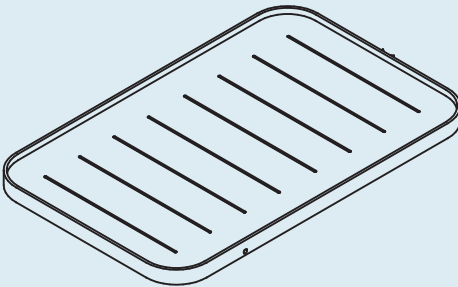

QTY 1

Upper Shelf

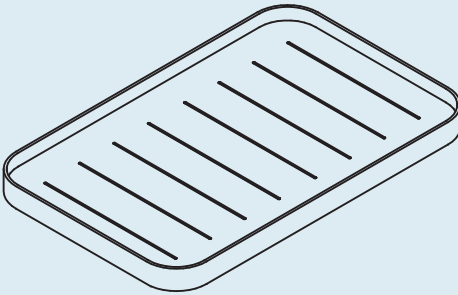

QTY 1

Lower Shelf

Step 01

ATTACH SHORT UPRIGHTS.

Assemble the bar cart on a soft surface to prevent damage during assembly. Attach the short uprights to the lower shelf as shown with the hardware provided.

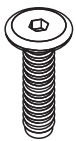
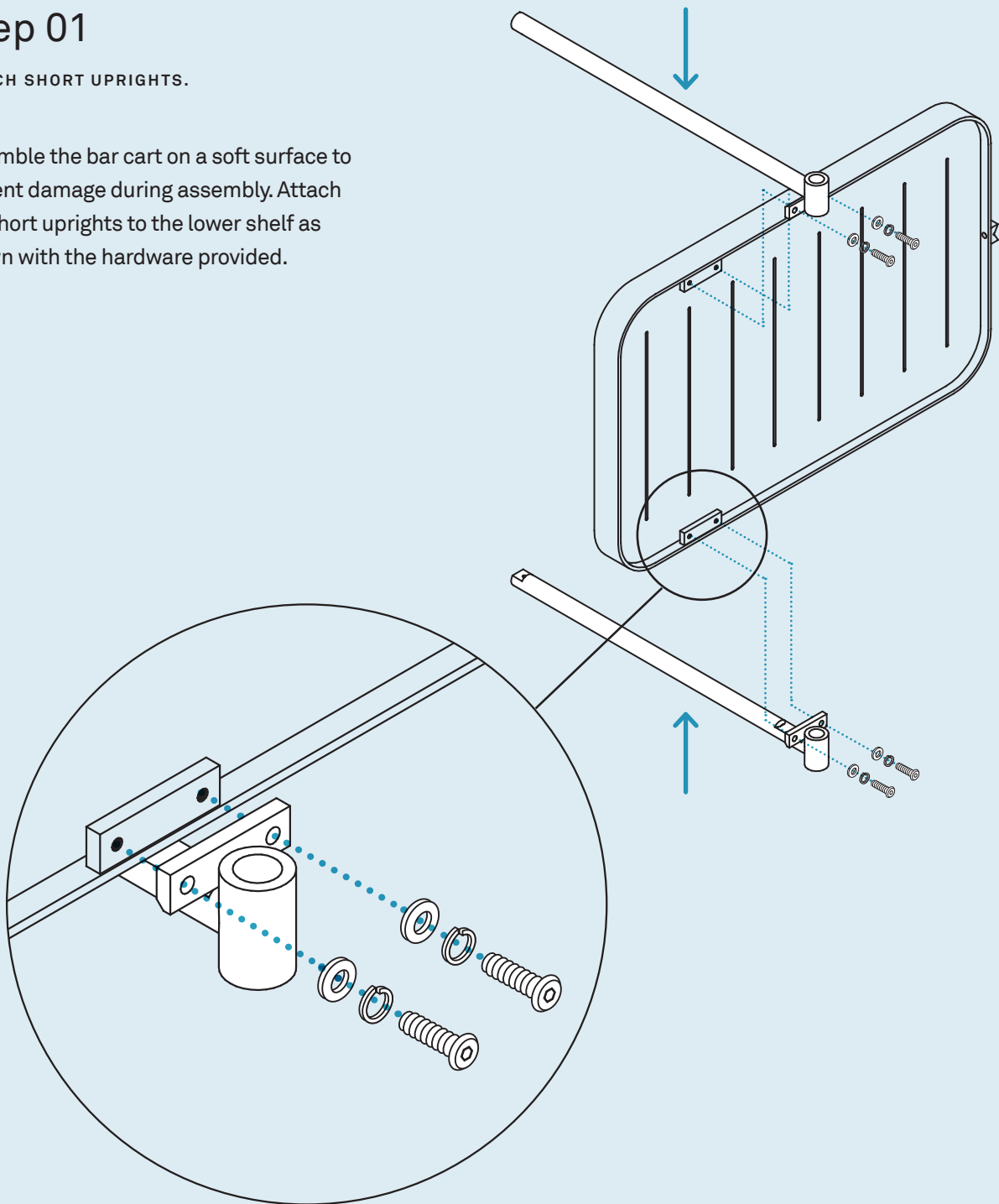

PT. 1694 x 4

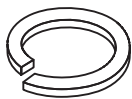

PT. 3001 x 4

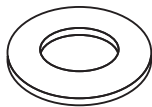

PT. 3002 x 4

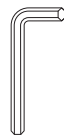





PT. 9004 x 1

Step 02

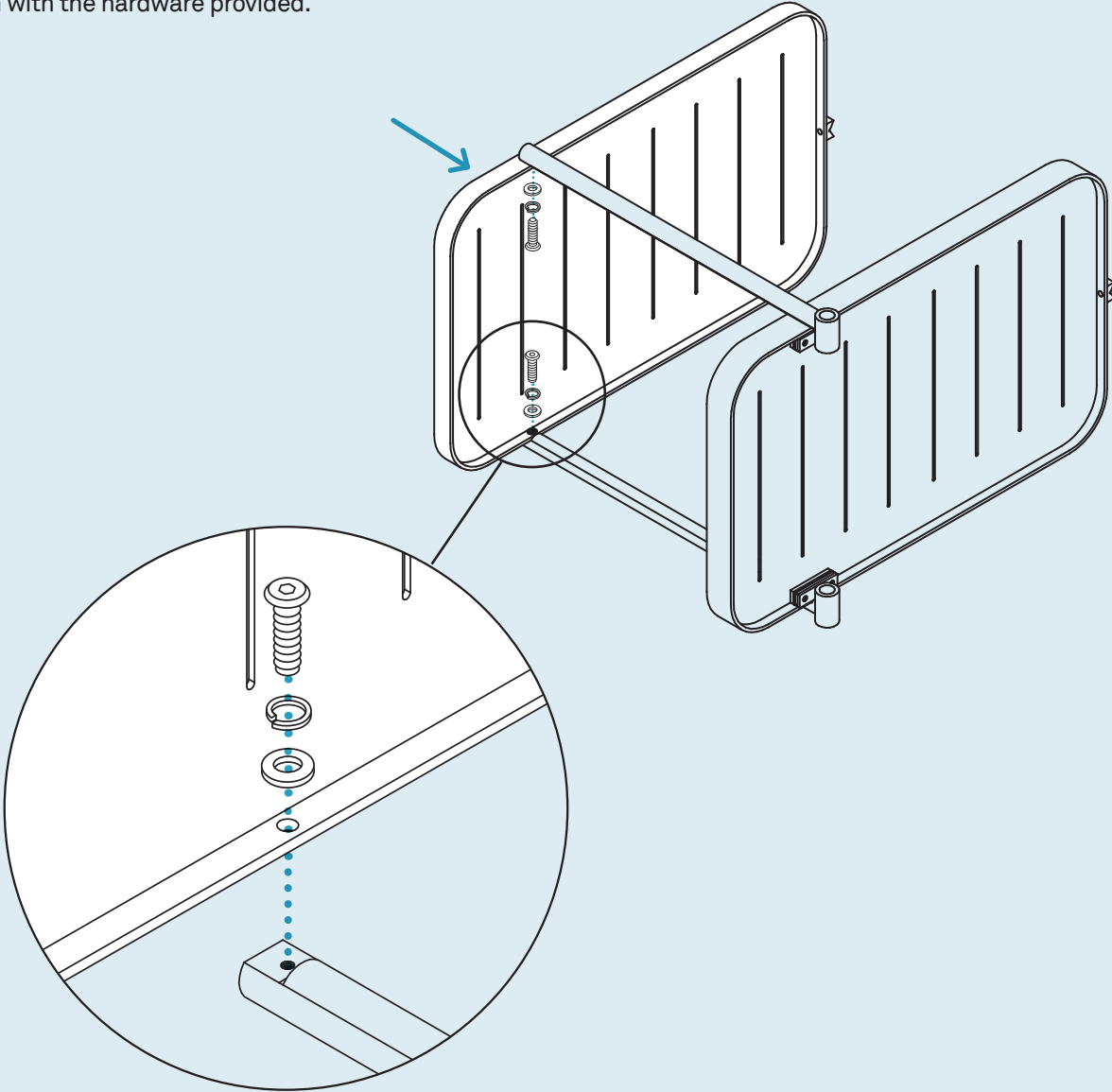
ATTACH UPPER SHELF.

Attach the upper shelf to the short uprights as shown with the hardware provided.

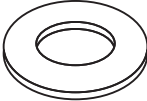

			
PT. 1694 x 2	PT. 3001 x 2	PT. 3002 x 2	PT. 9004 x 1

Step 03

ATTACH TALL UPRIGHT.

Attach the tall upright to the shelves as shown with the hardware provided.

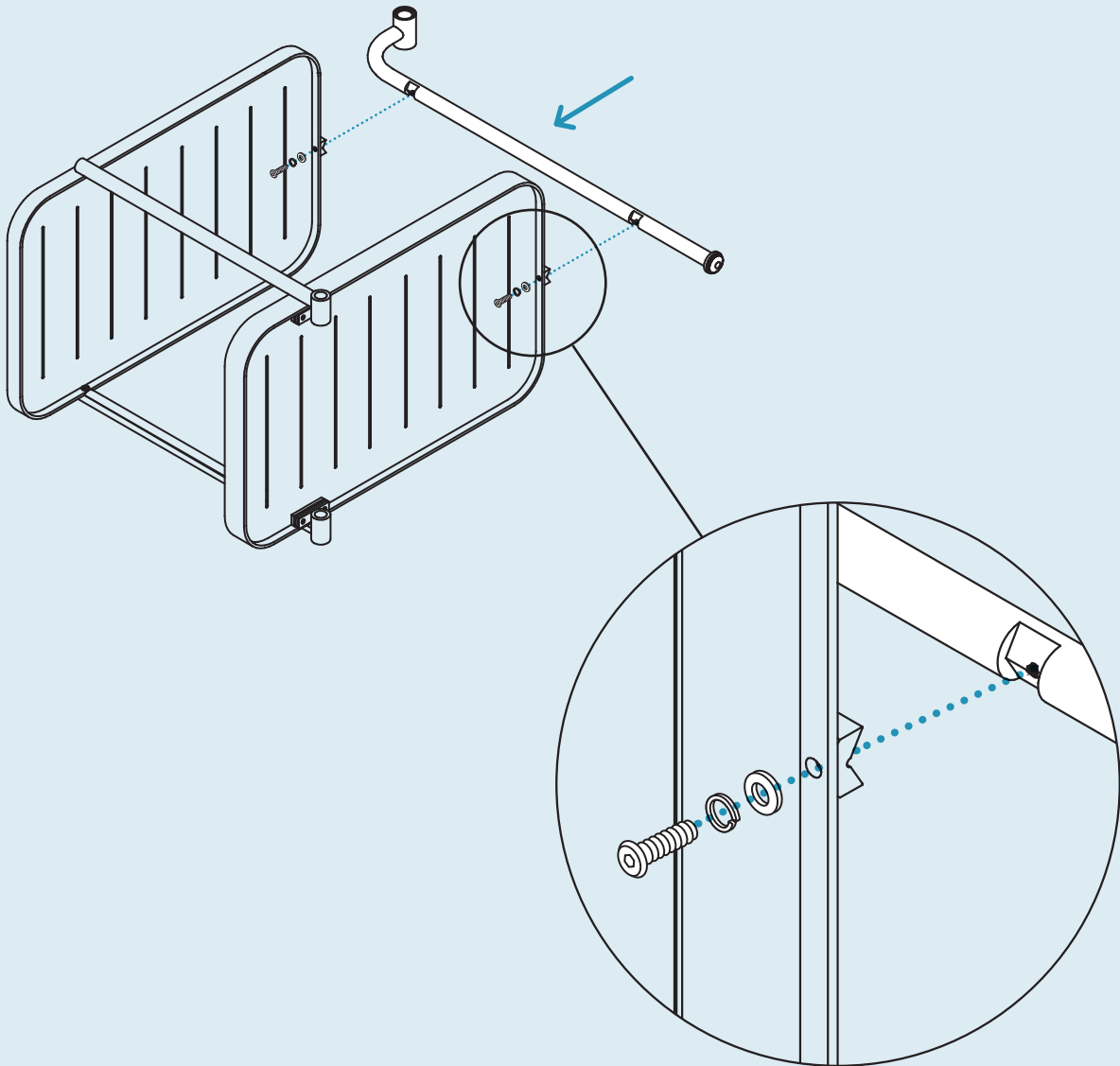

PT. 1695 x 2

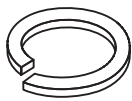

PT. 3001 x 2

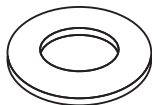

PT. 3002 x 2

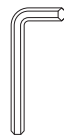

PT. 9004 x 1

Step 04

ATTACH WHEELS.

Attach the wheels to the short uprights as shown with the hardware provided.

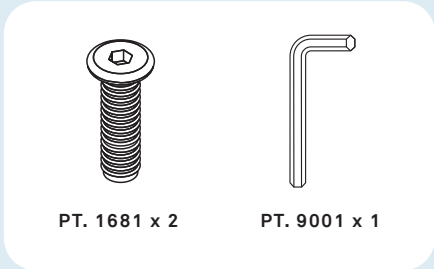
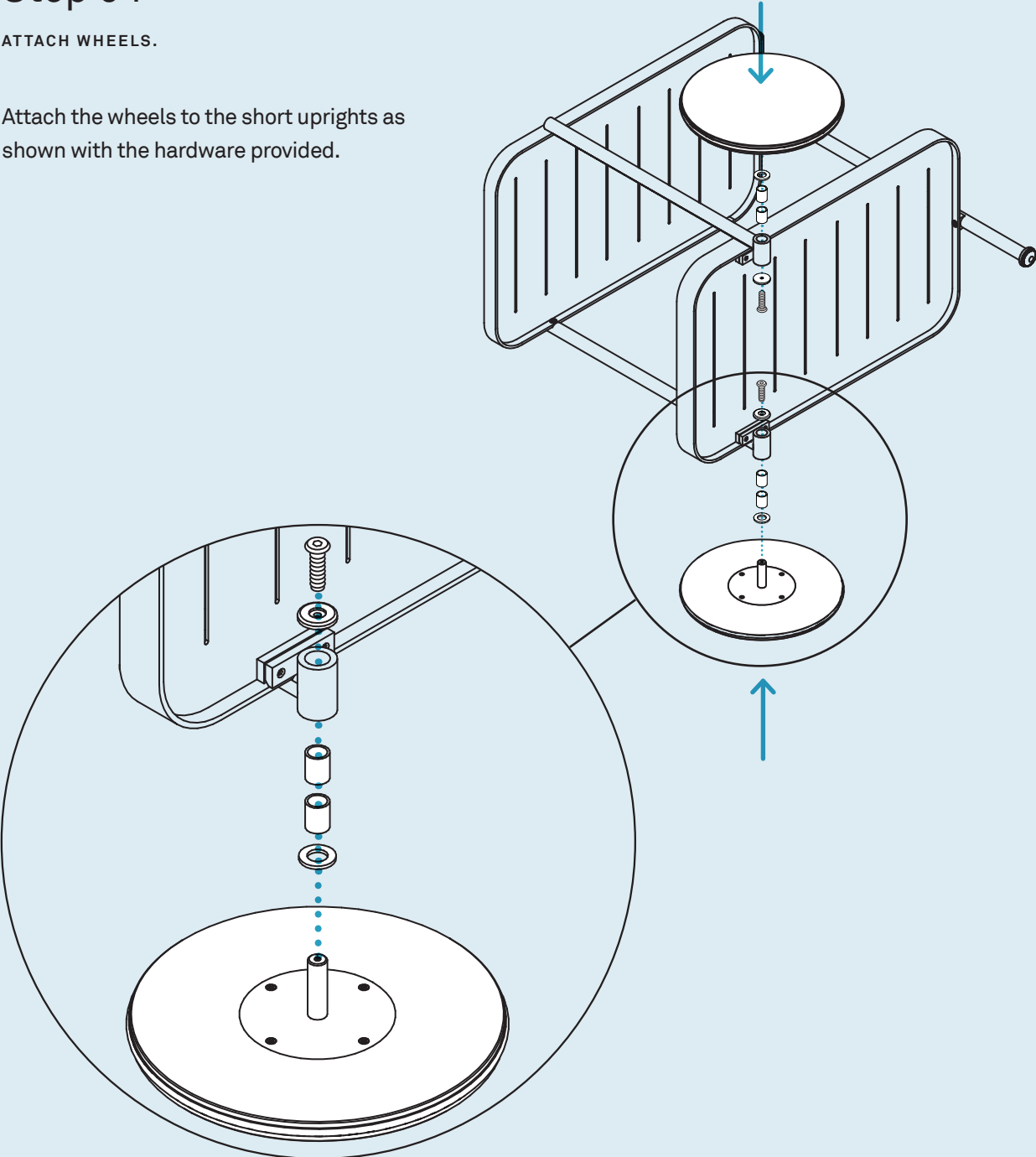

Step 05

ATTACH HANDLES AND PLACE TRAY.

Attach handles by threading them together in the tube location as shown.

Place tray on shelf surface to complete assembly.

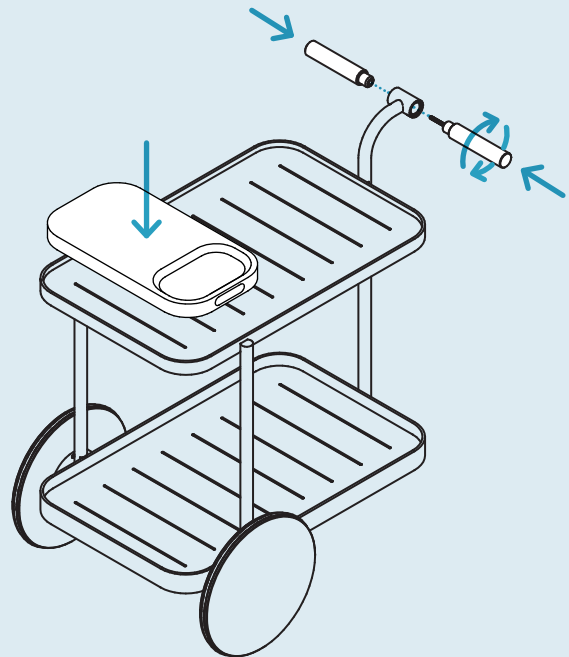

Additional Information

CLEAN METAL

Clean metal surfaces with a slightly damp, soft cloth. To remove dirt and fingerprints, use a quality cleaner formulated for metal furniture. Wipe completely dry with a soft cloth.

TEAK NOTES

Our teak is sustainably sourced Grade A solid wood. Teak's natural characteristics make it highly suitable for outdoor use. Keep in mind, graining and color may differ between pieces due to natural variations in the wood. Teak also weathers to a silver-gray patina over time. How much and how quickly it changes depends on climate, exposure to elements and level of care. Temperature changes cause teak to naturally expand and contract, sometimes resulting in hairline cracks. These should not affect the structural integrity of the design.

TEAK CARE

Teak's natural oils make it ideal for outdoors—preventing rot and making it resistant to fungus and wood-boring insects. Avoid letting water stand on surfaces. This can cause teak's natural oils to surface and appear as water stains. Over time, exposure to moisture can also raise the wood grain. Simply sand with fine sandpaper to smooth it out.

To keep your teak looking extra pretty, we recommend covering it when not in use. If you prefer your teak less silver-gray, we suggest using Bayes Teak Cleaner and Restorer to help maintain its original color or bring some of it back if already weathered. Apply according to manufacturers' instructions for best results.